



Phoenix, AZ USA

Email: [customercare@advancedairgroup.com](mailto:customercare@advancedairgroup.com)

[www.advancedairgroup.com](http://www.advancedairgroup.com)



**In Duct Environmental System**

## **Installation & Operation Manual**

Models:

IDES - 3000, IDES - 6500, IDES - 10K, IDES - 13K

Congratulations on your purchase of an Advanced Air In Duct Environmental System. This device is designed to be installed into the supply or return air duct of an existing HVAC system. Please read and follow all installation, service and operating procedures outlined in this manual. Use only genuine Advanced Air replacement parts available from your Independent HVAC or Electrical Contractor.

*If you have any questions concerning this or any Advanced Air product, contact your Independent HVAC Contractor.*

*For future reference, please record the name and phone number of your Independent HVAC Contractor:*

Name: \_\_\_\_\_

Phone: \_\_\_\_\_ - \_\_\_\_\_ - \_\_\_\_\_

## CONTENTS

Contents.....	1
Warranty .....	2
Product Contents .....	4
Installation Hardware .....	4
Recommended Installation Tools .....	4
Installation Requirements .....	5
Recommended Installation Location .....	6
Warnings .....	7
Installation Instructions .....	9
Maintenance / UV Lamp Indicator .....	10
Replacement Parts .....	10
Changing the UV Lamp & Catalyst Filter.....	11
Changing the Ballast .....	13
Specifications .....	15
Troubleshooting .....	16
Parts Assembly .....	16

## TROUBLE SHOOTING

Issue	Possible Cause	Solution
Device does not turn on.	Incorrect Electrical connection	Check the power source and the devices connection
Device does not turn on.	Ballast damaged	Replace Ballast
UV Working Indicator light won't illuminate when device is ON.	UV Lamp is burnt out / not operating.	Replace UV Lamp

## PARTS ASSEMBLY

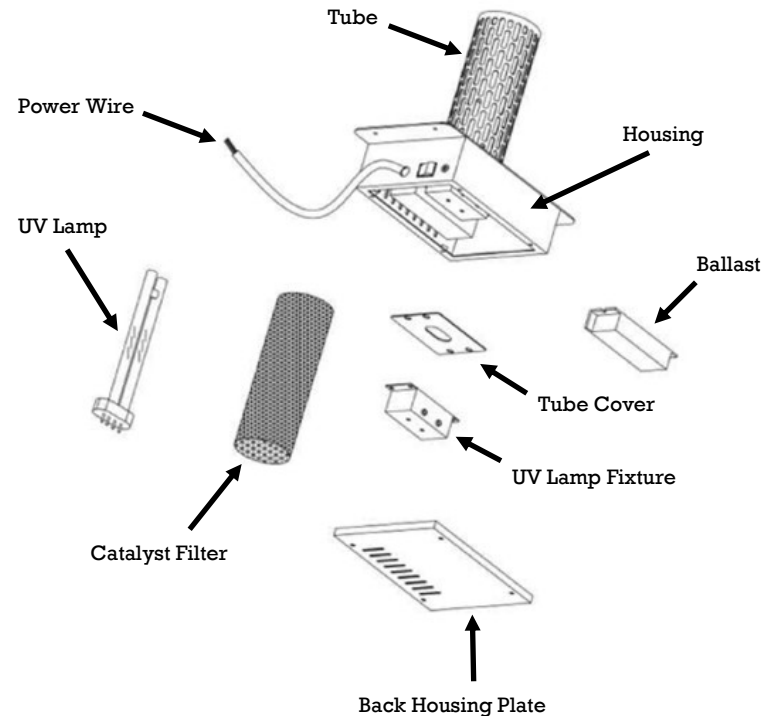

## SPECIFICATIONS

Please refer to your particular model listed below.

	<b>IDES-3000</b>	<b>IDES-6500</b>
Distribution	Via Air Handler	Via Air Handler
HVAC Size	2 - 7 Ton	8 - 15 Ton
Connection	Plug	Plug
Wire Length	20'	15'
Voltage	120VAC	120VAC
Amps	0.3 Amp	0.33 Amp
Power	13W	18W
Frequency	50 - 60Hz	50 - 60Hz
Operating Temperature	5°F - 140°F (-15°C - 60°C)	5°F - 140°F (-15°C - 60°C)
UVC Lamp	254nm Life: 12,000hrs.	254nm Life: 12,000hrs.
Weight	4.0 lbs	4.2 lbs

	<b>IDES-10K</b>	<b>IDES-13K</b>
Distribution	Via Air Handler	Via Air Handler
HVAC Size	15 - 22 Ton	23 - 30 Ton
Connection	Plug	Plug
Wire Length	15'	15'
Voltage	120VAC	120VAC
Amps	0.44 Amp	0.66 Amp
Power	24W	36W
Frequency	50 - 60Hz	50 - 60Hz
Operating Temperature	5°F - 140°F (-15°C - 60°C)	5°F - 140°F (-15°C - 60°C)
UVC Lamp	254nm Life: 12,000hrs.	254nm Life: 12,000hrs.
Weight	4.4 lbs	5.0 lbs

## WARRANTY INFORMATION

**PLEASE REGISTER YOUR WARRANTY AT:**  
[www.advancedairgroup.com/warranty-registration](http://www.advancedairgroup.com/warranty-registration)

### LIMITED 3 YEAR WARRANTY

Customer should not repackage and ship the Advanced Air IDES unit due to possibility of irreparable damage. For warranty service, please contact your Independent HVAC or Electrical Contractor for the address of the nearest service center or email: [customer@advancedairgroup.com](mailto:customer@advancedairgroup.com)

### WHAT IS COVERED BY THIS WARRANTY

We warrant the Advanced Air IDES unit to the customer, subject to the conditions below, against defects in workmanship or material, provided that products are returned to a service location within the following time periods:

- Advanced Air IDES (excluding the Advanced Air Catalyst Filter and UV Lamp) within three (3) years of the date of purchase.
- Advanced Air UV Lamp within nine (9) months of date of purchase if the Advanced Air IDES is connected to a power source where the IDES Lamp is "ON" 100% of the time. If the IDES unit is connected to the fan circuit where the IDES unit cycles "ON and OFF" with the HVAC system fan, the Advanced Air UV Lamp is covered by a ninety (90) day warranty from the date of purchase.

### INSTALLATION AND MAINTENANCE REQUIREMENTS

This warranty is expressly conditioned upon proper installation, operation, cleaning and maintenance, all in accordance with this Installation and Operation Manual. Failure to meet any of these requirements will void this warranty. Servicing of your Advanced Air IDES product by parties other than our authorized representatives and/or using parts other than genuine Advanced Air parts will also void this warranty.

### HOW TO OBTAIN WARRANTY SERVICE

Customer must contact their Independent HVAC or Electrical Contractor and provide proof of purchase within the above time periods. Advanced Air will repair or replace and return the product, without charge and within a reasonable period of time, subject to the conditions herein, if its examination shall disclose any part to be defective in workmanship or material. If we, in our discretion, are unable to repair the product after a reasonable number of attempts, we will provide either a refund of the purchase price or a replacement unit, at Advanced Air's option. We reserve the right to inspect and/or require confirmation of installation provider and method.

### WHAT IS NOT COVERED BY THIS WARRANTY

Ordinary wear and tear shall not be considered a defect in workmanship or material. These warranties do not apply for loss or damage caused by accident, shipping, fire, abuse, misuse, improper installation, leaking, modification, misapplication, or by any repairs other than those provided by our authorized Service Center. This warranty is non-transferable .

## WARRANTY INFORMATION CONT'D

### MISSING SERIAL NUMBERS AND UNAUTHORIZED CHANNELS

If a valid serial number is missing from the product, the warranty will be voided. Advanced Air IDES products are for sale through authorized Independent HVAC or Electrical Contractors only. Warranties are voided if a product is purchased through unauthorized channels; this includes company sponsored or independent websites that are not authorized to use Advanced Air's trademarked names, images and logos as well as Internet auction sites (e.g. eBay and craigslist). To confirm warranty coverage prior to purchasing a product, contact Advanced Air at: [customercare@advancedairgroup.com](mailto:customercare@advancedairgroup.com) with the serial number located on the back of the unit.

### EXCLUSION OF OTHER WARRANTIES AND CONDITIONS

EXCEPT AS PROVIDED HEREIN, WE MAKE NO REPRESENTATION OR WARRANTY OF ANY KIND. ALL OTHER WARRANTIES OF ANY KIND, EXPRESS OR IMPLIED, ARE HEREBY EXPRESSLY DISCLAIMED, INCLUDING ANY IMPLIED WARRANTY OF MERCHANTABILITY OR FITNESS FOR A PARTICULAR PURPOSE.

### LIMITATION OF LIABILITY FOR SPECIAL, INCIDENTAL, OR CONSEQUENTIAL DAMAGES

WE SHALL NOT IN ANY CASE BE LIABLE FOR SPECIAL, INCIDENTAL OR CONSEQUENTIAL DAMAGES ARISING FROM BREACH OF EXPRESSED OR IMPLIED WARRANTIES, CONDITIONS, GUARANTEES OR REPRESENTATIONS, BREACH OF CONTRACT, NEGLIGENCE, INSTALLATION OR ANY OTHER LEGAL THEORY. Such excluded damages include, but are not limited to, loss of profits or revenue, and loss of the use of the products, and any loss caused by leaks or other water damage.

### FOR U.S. APPLICATION ONLY

This warranty gives you specific legal rights, and you may also have other rights which vary from state to state. Some states do not allow limitations on warranties, or on remedies for breach. In such states, the above limitations may not apply to you.

### FOR CANADIAN APPLICATION ONLY

Exclusion of Subsequent Owners: Except as otherwise required by applicable legislation, this warranty is not transferable. This warranty gives you specific legal rights and you may also have other rights which vary from province to province. Some provinces and territories do not allow limitations on warranties, or on remedies for breach. In such provinces or territories, the above limitations may not apply to you. If any provision of this warranty or part thereof is held by a court of competent jurisdiction to be invalid, illegal, or unenforceable, the validity, legality and enforceability of the remaining provisions or parts thereof will not in any way be affected or impaired within the jurisdiction of that court. This entire warranty shall continue to be valid, legal and enforceable in any jurisdiction where a similar determination has not been made.

### SERVICE

For service questions or inquiries please contact us at: [customercare@advancedairgroup.com](mailto:customercare@advancedairgroup.com)

### STEP 2:

Remove the back plate on the ballast housing by removing the 4 screws.

Remove 4 screws from back plate.

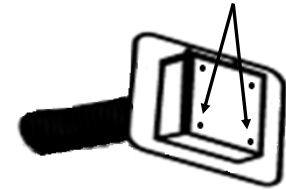

**NOTE:** The IDES device does NOT need to be removed from the ductwork to change the Ballast.

### STEP 3:

- Remove the UV Lamp Fixture by removing the 4 screws (A).
- Remove the Ballast by removing the two securing screws.
- Remove the Ballast wiring and dispose of the old Ballast properly.

**NOTE:** Make note of how wiring connects as you will need to know this in the next step.

Ballast: Remove 2 securing screws.

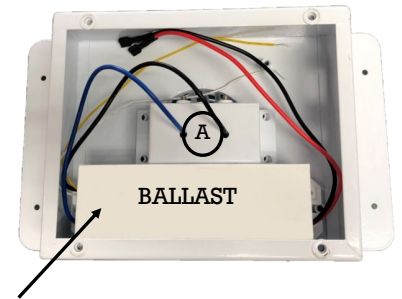

### STEP 4:

- Attach wiring to the new Ballast.
- Install and secure the new ballast using its 2 screws.
- Install the UV Lamp Fixture by securing the 4 screws (C).

Ballast: Install and Secure using 2 screws.

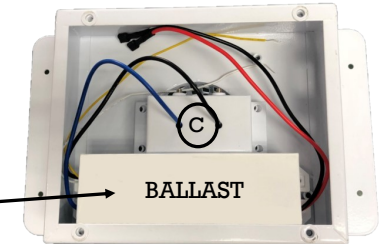

### STEP 5:

- Secure the back housing plate to the IDES housing using the 4 screws.



Secure back plate using 4 screws.

### STEP 6:

- Connect IDES device to the power source.
- Turn the power back to "ON" at the breaker or fuse panel.
- Turn the IDES device "ON" by pressing the ON/OFF switch located on the side of the unit. The UV Working Indicator light will turn on.

**BALLAST REPLACEMENT IS COMPLETE.**

**STEP 9:**

Insert the IDES device into the duct and fasten in place using the 4 mounting screws.

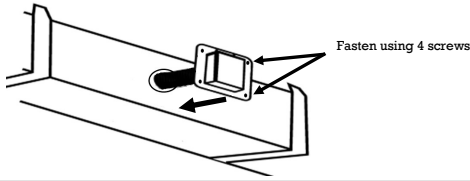

**STEP 10:**

- A. Connect IDES device to the power source.
- B. Turn the power back to "ON" at the breaker or fuse panel.
- C. Turn the IDES device "ON" by pressing the ON/OFF switch located on the side of the unit. The UV Working Indicator light will turn on.

**UV LAMP & CATALYST FILTER SERVICE IS COMPLETE.**

### CHANGING THE BALLAST



### WARNING

**UV Light in operation. UV Light can cause severe and permanent eye damage. Protect your eyes from UV light, do not look at this product while power is on and/or in operation. Turn the device OFF and disconnect the power before opening or removing this device to service or change the UV Lamp.**



### CAUTION

**RISK OF ELECTRIC SHOCK! Disconnect power at breaker or fuse panel before servicing unit. Always follow OSHA electrical lockout safety requirements to prevent accidental exposure to electrical energy during service or maintenance.**

**IMPORTANT: Disconnect all power to the IDES device before beginning any service work.**

**STEP 1:**

Disconnect power at breaker or fuse panel. Turn the IDES device "ON/OFF" switch to the "OFF" position and disconnect the power.  
\*Always follow OSHA electrical lockout safety requirements to prevent accidental exposure to electrical energy during service or maintenance.

## PRODUCT CONTENTS

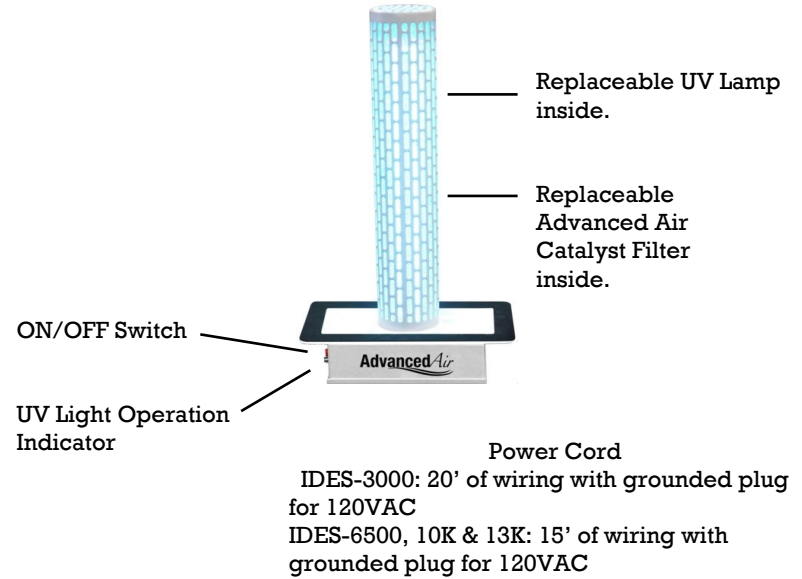

### INSTALLATION HARDWARE (SUPPLIED)

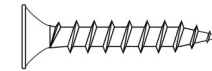

(4) Self-tapping screws.

### RECOMMENDED INSTALLATION TOOLS



Power Drill & Bits

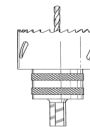

3" Hole Saw for metal (recommended)



Screw Driver



Wire Cutter



Tin Snips (for metal ductwork)

**You may also need:**



Utility Knife



Dust Mask



Eye Protection



Gloves

# INSTALLATION REQUIREMENTS

**WARNING:** This unit must be installed by a licensed HVAC or Electrical contractor. Failure to do so will void the products warranty.

1. Minimum dimension of rectangular metal ductwork required:

Model	Rectangular Duct Size	
	Minimum Width	Minimum Height
IDES - 3000	10"	8"
IDES - 6500	14"	10"
IDES - 10K	20"	10"
IDES - 13K	26"	12"

**NOTE:** This chart indicates minimum duct sizes. Installation of IDES units into larger ducts sizes than what is listed in this chart is acceptable.

2. The ductwork around the installation area should be clean and dry to ensure a proper seal once installed. If the duct is insulated, the insulation will need to be removed so the metal duct is exposed where the IDES unit is to be installed.

3. When installing near a furnace or heating coils, ensure that the temperature of the air passing past the Advanced Air IDES does not exceed 60°C or 140°F.

4. A circular opening of 3" in diameter will need to be cut into the existing ductwork to install the unit properly.

## Power Connection Requirements:

**All Models:** These devices are designed for operation from a 120VAC power source either by being plugged into a standard 120V electrical outlet or removing the plug end to expose lead wires and wiring to a constant power source with a voltage input of 120VAC.

**NOTE:** Unit requires continuous power. Do not install where power to the unit will be cycled on and off.

## STEP 4:

- Remove the UV Lamp Fixture found in the center of the inner housing by removing the 4 screws.
- Remove the used UV Lamp from the fixture and dispose of it properly.

UV Lamp Fixture: Remove 4 securing screws.

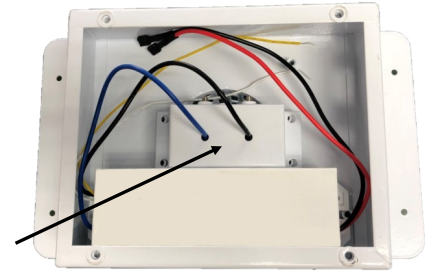

## STEP 5:

- Remove the Ballast by removing the two securing screws.
- Remove the Tube cover laying over the opening.
- Remove the Catalyst Filter and dispose of properly.

Ballast: Remove 2 securing screws.

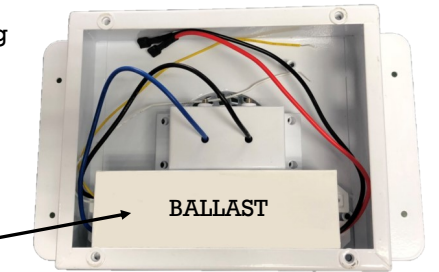

## STEP 6:

- Install the new Catalyst filter by inserting it into the empty Tube.
- Place the Tube cover over the opening.
- Install the ballast and secure it using the 2 screws.

A. Catalyst Filter: Install into Tube.

C. Ballast: Install using 2 securing screws.

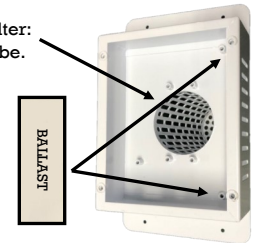

## STEP 7:

- Insert the new UV Lamp into the Tube Cover opening and plug the UV Lamp into the UV Lamp Fixture.
- Secure the UV Lamp Fixture using its 4 screws.

UV Lamp Fixture: Secure using 4 securing screws.

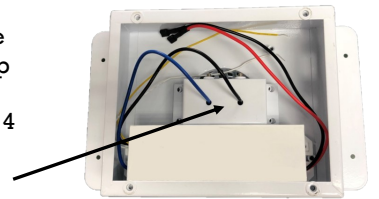

## STEP 8:

- Secure the back housing plate to the IDES housing using the 4 screws.

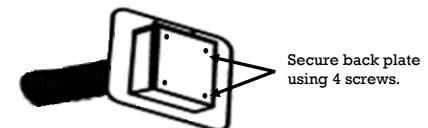

## CHANGING THE UV LAMP & CATALYST FILTER

### **WARNING**

**UV Light in operation. UV Light can cause severe and permanent eye damage. Protect your eyes from UV light, do not look at this product while power is on and/or in operation. Turn the device OFF and disconnect the power before opening or removing this device to service or change the UV Lamp.**

### **CAUTION**

**RISK OF ELECTRIC SHOCK! Disconnect power at breaker or fuse panel before servicing unit. Always follow OSHA electrical lockout safety requirements to prevent accidental exposure to electrical energy during service or maintenance.**

**IMPORTANT: Disconnect all power to the IDES device before beginning any service work.**

#### **STEP 1:**

Disconnect power at breaker or fuse panel. Turn the IDES device "ON/OFF" switch to the "OFF" position and disconnect the power to the device.

\*Always follow OSHA electrical lockout safety requirements to prevent accidental exposure to electrical energy during service or maintenance.

#### **STEP 2:**

- A. Remove the IDES device from the HVAC duct by unscrewing the 4 fastening screws located in each corner of the devices mounting plate. Once unscrewed, remove the IDES device from the duct.
- B. Wipe any dust from the casing with a dry cloth.

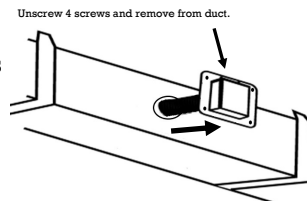

#### **STEP 3:**

Remove the back plate on the housing by removing the 4 screws.

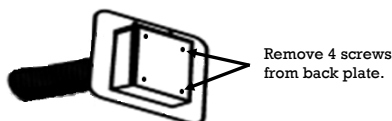

## RECOMMENDED INSTALLATION LOCATION

Advanced Air IDES devices can be installed in various locations throughout an HVAC systems ductwork. The following locations are suggestions listed in order of best placement.

**WARNING:** Advanced Air IDES devices are designed to be installed in indoor environments away from the elements and extreme outdoor temperatures. Advanced Air IDES devices are designed to operate in environments between 5°F - 140°F (-15°C - 60°C). DO NOT install directly into the supply plenum of a heating system as temperatures in this location can exceed 140°F (60°C).

1. Upstream from the supply air plenum where air temperature does not exceed 140°F (60°C).  
\*Test & confirm plenum temperature prior to installing.
2. In the return air plenum with a minimum clearance of 12" from the air filter to avoid any risk of damaging the HVAC air filter.
3. At any point along the supply air ductwork where an appropriate electrical connection is also available.

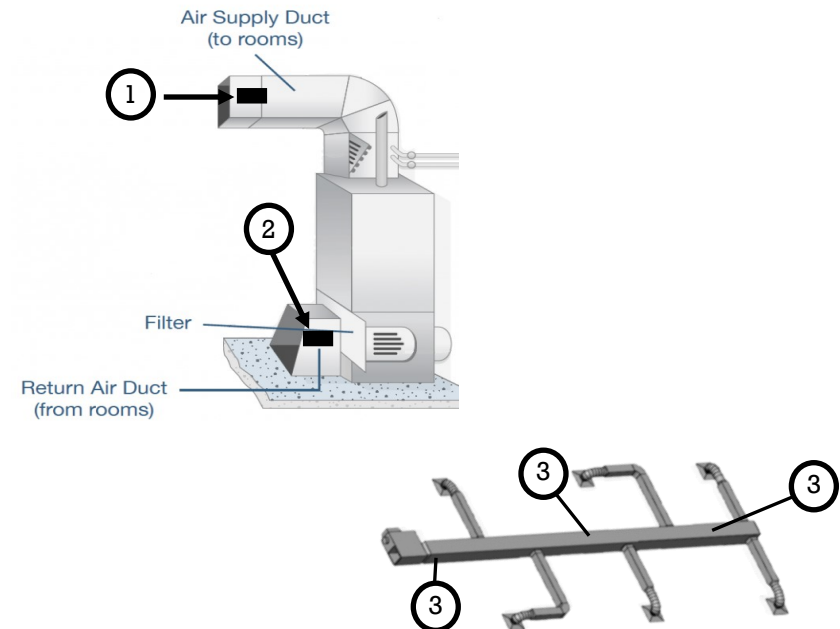



## WARNINGS



### DISCLAIMER

**Manufacturer is not responsible for any issues, injuries or damages caused as a result of:**

- **Misuse of the product.**
- **Placement of the product in location or in a manner which is not contained in this manual.**
- **Improper installation or products installed in a manner which does not follow the installation instructions contained in this manual.**
- **Any installation not performed by a licenced HVAC or Electrical contractor.**
- **Use of replacement parts not manufactured or supplied by the manufacturer.**



### CAUTION

**RISK OF ELECTRIC SHOCK!** Disconnect power at breaker or fuse panel before installing this device or performing any service/replacement of parts. Also, disconnect power to the unit and turn the units ON/OFF switch to the "OFF" position before performing any service, maintenance or parts replacement.

**\*Always follow OSHA electrical lockout safety requirements to prevent accidental exposure to electrical energy during installation or service/repair.**



### WARNING

**UV Light in operation. UV Light can cause severe and permanent eye damage. Protect your eyes from UV light, do not look at this product while power is on and/or in operation. Turn the device OFF and disconnect the power before opening or removing this device to service or change the UV Lamp.**

#### STEP 5:

Turn the IDES device "ON" by pressing the ON/OFF switch located on the side of the unit. The UV Working Indicator light will turn on.

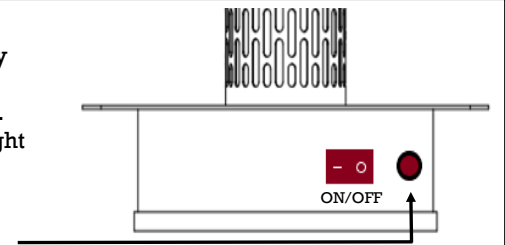

UV Working Indicator

## MAINTENANCE / UV LAMP INDICATOR

Your Advanced Air IDES unit requires no periodic maintenance beyond normal replacement of the UV Lamp and Catalyst Filter once every 12 - 16 months. The IDES UV Lamp has an effective life of up to 12,000 continuous hours.

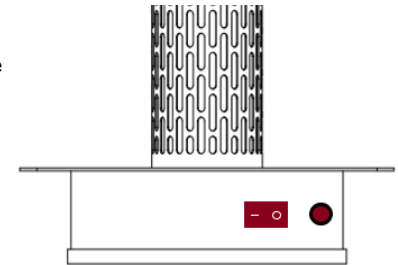

The UV Lamp "Working Indicator" light will illuminate when the UV Lamp is in use. If the Indicator Light does not illuminate while the unit has power, the UV Lamp and Catalyst Filter should be Replaced.

## REPLACEMENT PARTS

**For replacement parts, please call your local HVAC or Electrical Contractor who provided installation of the IDES device.**



UV Lamp

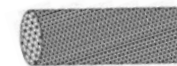

Catalyst Filter



Ballast

#### PART NUMBERS

	IDES-3000	IDES-6500	IDES-10K	IDES-13K
UV Lamp	UV-3000	UV-6500	UV-10K	UV-13K
Catalyst Filter	CF-3000	CF-6500	CF-10K	CF-13K
Ballast	BL-3000	BL-6500	BL-10K	BL-13K



## INSTALLATION INSTRUCTIONS

### IMPORTANT!

- Only qualified HVAC or Electrical contractors should install this device.
- Install with relevant building codes.
- Read this manual carefully including safety warnings prior to installing.

\*Installation of this product by anyone other than a licensed HVAC or Electrical contractor voids the warranty on this product.

### ⚠ ⚠ CAUTION

**RISK OF ELECTRIC SHOCK! Disconnect power at breaker or fuse panel before beginning to install this device. Always follow OSHA electrical lockout safety requirements to prevent accidental exposure to electrical energy during installation.**

#### STEP 1:

Prep the installation area by removing any insulation from the ductwork (if any) and wiping away any dust.

#### STEP 2:

Using a 3" metal hole saw, drill a 3" diameter hole into the metal ductwork at the desired installation location. This is where the tubular portion of the IDES device will be inserted inside the duct.

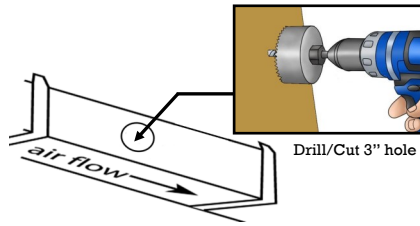

#### STEP 3:

Insert the tubular portion of the Advanced Air IDES device into the 3" hole. Fasten the IDES device to the wall of the duct by using the 4 screws provided.

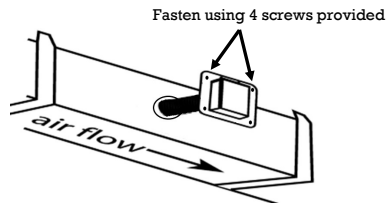

#### STEP 4:

**WARNING: Disconnect power at the breaker or fuse box before starting Step 4 especially if wiring direct to a 120V power source.**

**Important! Must be wired to constant power.**

Plug in the Advanced Air IDES device to a standard 120V outlet.

If direct wiring to a 120V power source start by removing plug end.

**Wire Colors are as follows:**

**Live/Hot Wire:** Brown (Connect to Live wire which is usually Black)

**Neutral:** Blue (Connect to Neutral wire which is usually White)

**Ground:** Green/Yellow (Connect to Ground wire which is usually Green)

### ⚠ WARNING

**This unit must be installed by a licensed HVAC or Electrical contractor. Failure to do so will void warranty of the product.**

### ⚠ WARNING

**Only use genuine Advanced Air replacement parts. Failure to do so will void the warranty. Failure to do so could also result in damage to the product, property, fire, serious injury or death.**

### ⚠ WARNING

**Only install this device in a dry environment. This device is NOT designed to be installed where water is present. Improper installation could result in electric shock, damage to property, fire, serious injury or death.**

### ⚠ WARNING

**To prevent damage to the unit, operating environment temperature must never exceed 140°F (60°C). Operating environment temperature must never be below 5°F (-15°C).**

### ⚠ WARNING

**Do not connect this unit to any voltage source greater than what is shown on the product label and in this manual in the specifications section located on page 15. This unit must never be used with; or connected to an extension cord. Doing so could cause damage to the unit and could cause damage to property, fire, serious injury or death.**

### ⚠ WARNING

**This device is designed to ONLY be installed in an indoor environment away from outdoor environment and elements.**